

USER MANUAL

ENGLISH - VERSION 2

VELOCE

PROFILE

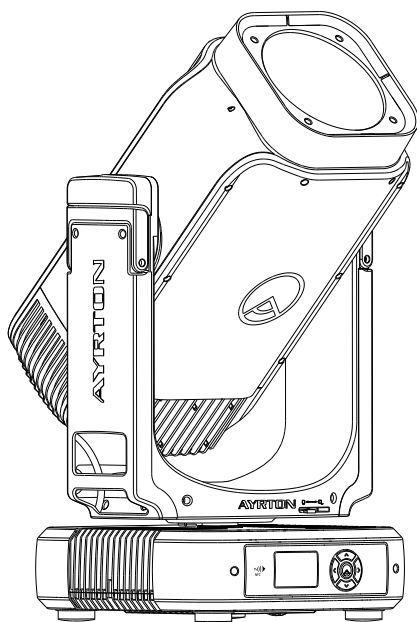

AYRTON

Digital Lighting



2 Rue de Vitruve,
91140 Villebon-sur-Yvette,
France

CONTENTS

1. SAFETY INSTRUCTIONS	3
2. FEATURES	4
3. FIXTURE OVERVIEW	4
4. DRAWINGS	4
5. INSTALLATION INSTRUCTIONS	6
6. DMX-512 CONTROL CONNECTION	6
7. DMX-512 CONNECTION WITH DMX TERMINATOR	7
8. DEVICE DMX START ADDRESS SELECTION	7
9. OPERATING INSTRUCTIONS OF THE INTERNAL DMX WIRELESS SYSTEM	7
10. DISPLAY	8
11. NFC	17
12. DMX PROTOCOL	17
13. ERROR MESSAGES	17
14. CLEANING AND MAINTENANCE	19

Keep this manual for future needs.

Errors and omissions for all information given in this user manual are possible.
All information is subject to change without prior notice.









1. SAFETY INSTRUCTIONS

1.1 > IMPORTANT SAFETY WARNINGS

This device has left the factory in perfect condition. In order to maintain this condition and to ensure safe operation, it is absolutely necessary for the user to follow the safety instructions and warning notes written in this user manual.

In order to install, operate and maintain the lighting fixture safely and correctly we suggest that the installation and operation be carried out by qualified technicians and these instructions be carefully followed.

CAUTION	
	High voltage. Risk of severe or fatal electric shock.
	Always disconnect mains supply before removing any fixture covers.
	Never look directly into the light source. Sensitive persons may suffer an epileptic shock.
	Blue light hazard: risk group 2.
	Fixture exposed to salt water should not be stored in its foam insert without being cleaned with fresh water first. It is best practice that fixture be stored dry.
	Never touch the device during operation. covers may be hot.
	<p>Warning: Changes or modifications to this unit not expressly approved by the party responsible for compliance could void the user's authority to operate the equipment.</p> <p>Note: This equipment has been tested and found to comply with the limits for a class a digital device, pursuant to part 15 of the FCC rules. These limits are designed to provide reasonable protection against harmful interference when the equipment is operated in a commercial environment. This equipment generates, uses and can radiate radio frequency energy and, if not installed and used in accordance with the instruction manual, may cause harmful interference to radio communications. Operation of this equipment in a residential area is likely to cause harmful interference in which case the user will be required to correct the interference at his own expense.</p>

Damage caused by the disregard of this user manual is not subject to warranty The dealer and manufacturer will not accept liability for any resulting defects or problems.

- If the device has been exposed to temperature changes due to environmental conditions, do not power on immediately. The resulting condensation could damage the device. Leave the device powered off until it has reached room temperature.
- Ensure the sealing rubber covers of powerCON TrueOne and XLR connectors are fitted properly when the device is not in use, to avoid water ingress.

- This device falls under protection-class I. Therefore, it is essential that the device be earthed.
- If either lenses or display are damaged (damage may include cracks or gashes in the material) they must be replaced.
- Electrical connections, such as replacing the power plug, must be performed by a qualified person.
- Make sure that the available voltage is not higher than that which is stated in this manual.
- Make sure the power cord is never crushed or damaged by sharp edges. If this should be the case, replacement of the cable must be done by an authorized dealer.
- If the external flexible power cord of this device is damaged, it shall be exclusively replaced by the manufacturer or their service agent or a similar qualified person in order to avoid injury.
- When the device is not in use or before performing maintenance, always disconnect the device from the mains. Only handle the power cord from the plug. Never pull the plug out of a socket by tugging the power cord.
- When powered on for the first time, some smoke or smell may occur. This is caused by coating on metal parts when heated and is normal. If you are concerned, please contact your distributor.
- Do not focus the beam onto flammable surfaces. The minimum distance between the exiting lens of the device and the illuminated surface must be greater than 4 meter.

CAUTION

Please be aware that damage caused by any modifications to the device are not subject to warranty Keep away from children and non-professionals.

1.2 > GENERAL GUIDELINES

- This device is a lighting effect for professional use on stages, in discotheques, theatres, etc. The device was designed for indoor and outdoor use.
- This fixture is only allowed to be operated within the maximum alternating current as stated in the technical specifications in section 2 of this manual.
- Handle the device with care avoid shaking or using force when installing or maintaining the device.
- If you use the quick lock cam when rigging the device, make sure the quick lock fasteners are located in the quick lock holes correctly and securely.
- Operate the device only after having familiarized yourself with its functions Do not permit operation by persons not qualified for operating the device Most damage is the result of unprofessional operation.
- Please use the original packaging if the device is to be transported.
- The applicable temperature for the device is between -20°C to 45°C. Do not use the device outside of this temperature range.
- The light source contained in this luminaire shall only be replaced by the manufacturer or his service agent or a similar qualified person.

CAUTION

For safety reasons, please be aware that all modifications to the device are forbidden. If this device is operated in any way different to the ones described in this manual, the product may suffer damage and the warranty becomes void. Furthermore, any other operation may lead to short-circuits, burns, electric shocks, etc.

2. FEATURES

POWER SUPPLY

- AC100-240 V~, 50/60 Hz
- Power Consumption: 1,300 W

OPTICS

- Beam aperture: 4° to 52°
- 180 mm frontal lens

LIGHT SOURCE

- 850 W LED white light engine
- Colour temperature output:
 - Veloce Profile S: 6,500 K
 - Veloce Profile TC: TBA
- CRI:
 - Veloce Profile S: 70
 - Veloce Profile TC: TBA

MOVEMENT

- Pan and tilt automatic repositioning
- Range: Infinite pan and tilt rotation

COLOURS

- Sophisticated CMY Colour mixing
- Variable CTO
- Variable CRI channel
- Static colour wheel with 7 complimentary colours

GOBOS

- 2 gobo wheels with 14 indexable rotating gobo HD glass gobos
- Adjustable-speed rotating gobo

FRAMING SYSTEM

- 4 individually shutter blades
- Rotation of the module: +/- 90°

IRIS DIAPHRAGM

- 15-blade iris diaphragm
- Range: 15% to 100% open

FROST

- 2 frost filters: one light, one heavy

PRISMS

- 2 combinable rotating and indexable prisms
- One 5-facet circular, one 4-facet linear

EFFECTS

- Focusable graphic animation effect-wheel
- Continuous rotation in both directions

DIMMER / STROBE

- Electronic dimmer from 0 to 100%
- Strobe effect: 1 to 25 flashes per second

HARDWARE FEATURES

- Graphic LCD display with flip function
- 5 menu buttons to set functions
- Integrated 4 wireless LumenRadio™ receiver
- IP65 XLR 5 pin connectors
- IP65 RJ45 connectors
- IP65 powerCON TRUE1 TOP connectors

CONTROL

- DMX 512 protocol
- DMX-RDM compatible
- Stand-alone mode, local control panel
- ArtNet™ & sACN protocol
- 67 DMX channels

COOLING SYSTEM

- Advanced liquid cooling system
- Selectable ventilation user modes
- Excess temperature protection

HOUSING

- Skeleton made of aluminium
- Base in die-cast composite alloy
- Heatsinks in aluminium and copper
- Moulded covers ABS PC (VO class)
- 4 handles on the yoke
- 4 heavy-duty feet
- IP65 protection rating (IP66 optional)

INSTALLATION

- 2 Omega ¼ turn brackets
- 4 ¼ turn mounting points
- Safety cable attachment point

OPERATING PARAMETERS

- Maximum permitted: 45° C (113°F)
- Minimum permitted: -20° C (-4°F)
- Minimum usage distance: 4 m (13.12 ft)

COMPLIANCE

- CE, UKCA, ETL

SIZE

- Product: 404 x 757 x 366 mm (l x h x d)
- Foam: 680 x 640 x 500 mm (l x h x d)

WEIGHT

- Product: 40.5 kg

3. FIXTURE OVERVIEW

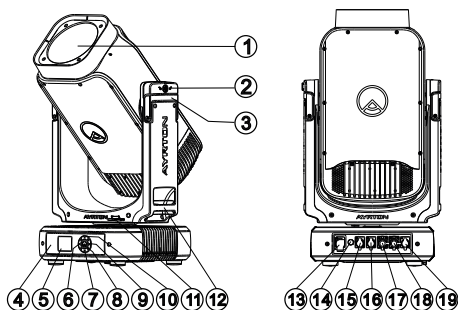

- | | | |
|----------------|------------------|--------------|
| 1. Front Lens | 7. Down-button | 13. Power In |
| 2. Tilt Lock | 8. Center-button | 14. Valve |
| 3. Handle | 9. Right-button | 15. RJ45 In |
| 4. NFC | 10. Up-button | 16. RJ45 Out |
| 5. Display | 11. Pan Lock | 17. DMXIn |
| 6. Left-button | 12. Handle | 18. DMXOut |

4. DRAWINGS

4.1 > FIXTURE DIMENSION

4.4 > ANIMATION WHEEL

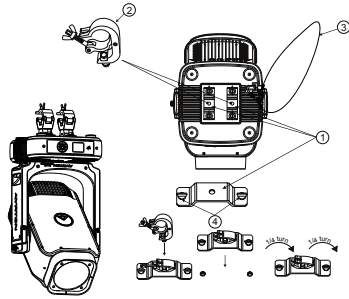
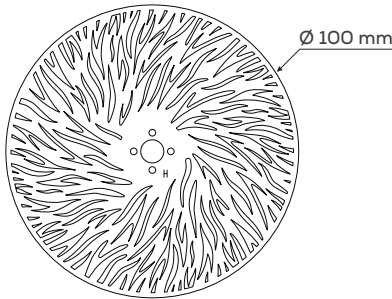

- | | |
|------------------|------------------------|
| 1. Omega bracket | 3. Safety rope |
| 2. Clamp | 4. Quick-lock fastener |

5. INSTALLATION INSTRUCTIONS

5.1 > RIGGING THE DEVICE

CAUTION

Please consider the respective national norms during the installation. The installation must only be carried out by a qualified person.

- The installation of the support structure has to be built and constructed in a way that it can hold 10 times the weight for 1 hour without any harming deformation.
- The installation must always be secured with a secondary safety attachment, e.g. an appropriate safety rope.
- Never stand directly below the device when mounting, removing or servicing the fixture.
- The operator has to make sure the safety relating and machine technical installations are approved by an expert before taking the device into operation for the first time.
- These installations have to be approved by a skilled person once a year.
- Overhead mounting requires extensive experience, including amongst others calculating working load limits, installation material being used, and periodic safety inspection of all installation material and the device. If you lack these qualifications, do not attempt the installation yourself. Improper installation can result in bodily injury.

5.2 > RIGGING USING THE OMEGA BRACKETS

CAUTION

This step is very important to ensure safe rigging of the fixture.

- Fix the clamp to the bracket by tightening the M12 nut and bolt to the bracket through the $\Phi 13$ hole in the middle of the bracket.
- Insert the quick lock fasteners of the first Omega holder into the respective holes on the bottom of the device. Tighten the quick lock fasteners fully clockwise.
- Install the second Omega holder.
- Pull the safe ty cable through the holes on the bottom of the base and over the trussing system or another suitable rigging point. Insert the end into the carabiner and tighten the safety screw.

5.3 > RIGGING DRAWINGS

CAUTION

Overhead rigging requires extensive experience, including (but not limited to) calculating working load limits, specifying installation/rigging materials, and periodic safety inspection of all installation material as well as the device. If you lack these qualifications, do not attempt the rigging of this device yourself. Improper installation/rigging can result in serious bodily injury.

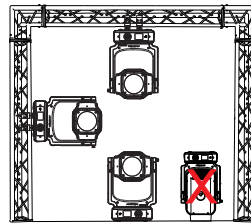

- **WARNING!** Please ensure that under no circumstances should the lens be placed face down on any surface, including the ground, as this may cause damage to the lens or impair its optical performance.
- Be sure this fixture is kept at least 0.1 m away from any flammable materials (decoration etc.).
- Always use and install a supplied safety cable as a safety measure to prevent accidental damage and/or injury in the event the clamp fails.
- Rig the projector high enough to provide clearance for people who may walk beneath the beam path or establishing a restricted access area that extends beyond the beam hazard distance.
- **WARNING!** Please **DO NOT** let other external intense lights to shine through the fixture front lens, it may cause significant internal damages!
- When install fixture outdoor at day time (with power off), please make sure that the fixture front lens is NOT facing the sun.
- When use fixture outdoor at day time (with power on), please avoid fixture front lens facing the sun.
- When fixture is on standby outdoor at day time (with power ON and no DMX signal), please make sure the "sun protection" mode is ON (default).

6. DMX-512 CONTROL CONNECTION

Connect the male side of the XLR cable to the female XLR output of your controller and the female side of the XLR cable to the male XLR input of the device. You can connect multiple devices together in a serial fashion. The cable needed should be two core, screened cable with XLR input and output connectors. Please refer to the diagram

below.

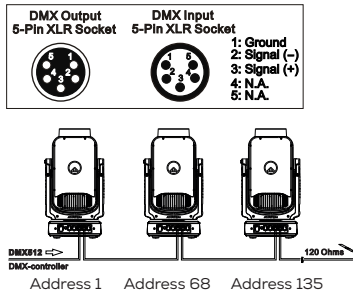

7. DMX-512 CONNECTION WITH DMX TERMINATION

For installations where the DMX cable has to run over a long distance or is in an electrically noisy environment, such as in a discotheque, it is recommended to use a DMX terminator. This helps in preventing corruption of the digital control signal caused by electrical noise. The DMX terminator is an XLR plug with a 120 Ω resistor connected between pins 2 and 3, which is then plugged into the output (female) XLR socket of the last fixture in the chain.

Please see illustrations below.

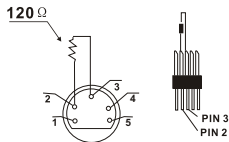

8. DEVICE DMX START ADDRESS SELECTION

All fixtures should be given a DMX starting address when using a DMX signal, so that the correct fixture responds to the correct control signals. This digital starting address is the channel number from which the fixture starts to "listen" to the digital control information sent out from the DMX controller. The allocation of this starting address is achieved by setting the correct address number on the display located on the base of the device.

You can set the same starting address for all fixtures or a group of fixtures, or set different addresses for each fixture individually. If you set the same address on all devices, all the devices will start to "listen to" the same control signal from the same channel number. In other words, changing the settings of one channel will affect all the fixtures simultaneously.

If you set a different address, each unit will start to "listen to" the channel number you have set, based on the quantity of control channels of the unit. That means changing the settings of one channel will affect only the selected device.

In the case of the LED moving head, in 67 channel mode, you should set the starting address of the first unit to 1, the second unit to 68 (67 + 1), the third unit to 131 (67 + 68), and so on.

9. OPERATING INSTRUCTIONS OF THE INTERNAL DMX WIRELESS SYSTEM

9.1 › EQUIPMENTS

DMX 512 controller, wireless transmitter, and the fixtures with wireless receiver.

9.2 › MESSAGE FROM THE LED INDICATOR

- Rapid flashing red/Green: Logging in to a transmitter.
- Slow flashing Red/Green: Logged on a transmitter and the DMX line is idle (No DMX is connected to transmitter).
- Solid Green: Logged on to a transmitter and receiving DMX data.
- Solid Red: Not logged on to a transmitter (free).

9.3 › WDMX IN THE MENU OF THE FIXTURE

On a fixture installed with wireless system, in order to switch between wireless control system and traditional DMX control (with cable), a new menu WDMX is added to the display board.

ON (Activate WDMX)

- When the fixture is on power and the WDMX is activated to ON status, but did not connect to the controller and did not log in to the transmitter, the fixture will search for the DMX signal source. If the fixture is connected to the DMX controller it can be controlled by DMX controller; if it is log in to the wireless transmitter, it can be controlled by the Transmitter.
- When the fixture is power off, and the WDMX is in ON status, if the fixture is connected to DMX controller After the fixture is power on, it can be controlled only by the DMX controller which connected. The fixture can log in the wireless transmitter, and receive only radio signal from transmitter but not DMX from the transmitter.

OFF (De-activate WDMX)

- In this status, wireless system is not activated, so the fixture can not log in the transmitter.

REST (Reset WDMX memory)

- Can remove the fixture from the connection with the transmitter, the fixture become free and ready to log in any transmitter.

9.4 › SET UP THE WIRELESS SYSTEM

- Connect the transmitter with the DMX controller.
- To make the fixture installed with wireless receiver log in to the transmitter.
 - Initially the indicator on the receiver fixture should be in Solid red.
 - Press and hold the configuration button on transmitter for less than 3 seconds the red/green LEDs on the transmitter and the receiver fixture will flash rapidly for about 5–10 seconds while the system goes through its setup procedure.
 - Once the receiver fixture is logged in to the transmitter (T1), the fixture with wireless receiver will keep the memory, even if restart the power, this unit will log in the transmitter (T1) automatically.
- Use the DMX 512 to control the fixture.

9.5 › REMOVE THE RECEIVERS FROM TRANSMITTER (T1) AND TO LOG IN TO ANOTHER TRANSMITTER (T2)

Case 1: Remove a receiver

- On the control board of the fixture, enter menu to activated the function of REST.
- The LED for wireless on the fixture should turn to Solid red; the receiver can log out from the transmitter (T1).
- Press the configuration button on transmitter (T2) for less than 3 second, then the fixture will start to connect with the transmitter (T2).

Case 2: Remove all receivers from a transmitter (T1) to log in to T2







- Press and hold the configuration button on the T1 as least 5 seconds, can clear the connection with all the fixtures.
- All the red/green LEDs on the receiver fixtures will turn to Solid red to indicate that the receivers are unassigned and removed from the transmitter (T1).

PS:

- Please log the receivers out from the transmitter after every job so that the receivers are in free un assigned state and ready to be assigned to a transmitter.

• Do not connect the fixture which is under the communication of wireless system to the DMX controller, otherwise it will cause interference from the DMX controller.

10. DISPLAY

- The Display offers several features: you can set the starting address run the pre-programmed program or reset the device.
- The main menu is accessed by double clicking  button until the display starts flashing.
- Browse through the menu by pressing , ,  or  button.
- Press  for 2 seconds in order to exit menu, double click  for confirm. After accessing the edit mode, the unit will automatically exit to the main menu after 15 seconds from the last button press.
- When the unit is powered on if no data signal is connected after 1 minute then the display will switch off automatically.

DEFAULT SETTINGS SHADED

Address				
Address	DMX Address: 001-XXX Decimal Universe: XXXXX Net: XX Sub-Net: XX Universe: X Signal: DMX/WDMX/Art-Net/sACN	DMX Address Decimal Universe Net Sub-Net Universe Signal		
Mode				
User Mode	Extend Mode User Mode A User Mode B User Mode C	User's mode to change channel numbers		
Options				
Status	No DMX Mode Sun Protection Pan Reverse Tilt Reverse Pan Degree Tilt Degree Feedback Encoder Select Init PAN Init TILT Prerig INIT Reset Mode Pan/Tilt Spd CMY Spd Zoom/Focus Spd Framing Mode Reset LED Fade Hibernation DMX Output Data Collect 4G/Wifi Wifi Info	Close/ Hold /Auto ON/OFF ON/OFF ON/OFF 630/540 270/540 ON/OFF Photoelectric/Magnet ON/OFF ON/OFF ON/OFF Fast/All Rot Gobos Fast/Medium/Slow/FS Mode Fast/Medium/Slow Fast/Medium/Slow Constant OFF/Constant ON ON/OFF OFF: 01M-99M ON/OFF Agree/Disagree 4G/Wifi No/Yes	Auto run if no DMX Sun Protection Pan Reverse movement Tilt Reverse movement Pan Degree Select Movement Feedback Encoder Select Init PAN Init TILT Prerig INIT Reset Mode Movement Speed CMY Spd Zoom/Focus Spd Framing Mode Reset LED Fade Stand by Mode DMX Output Data Collect Choose 4G or Wifi Wifi Information	
Options				
Service PIN	Service PIN Set IP Set Mask IP Reset From Mac DHCP Iot Lock Enable Cross Load SW Cir Error Info	Password = XXX xxx.xxx.xxx.xxx xxx.xxx.xxx.xxx ON/OFF ON/OFF ON/OFF ON/OFF ON/OFF	Service Password*=050* Set IP Set Mask IP Reset From Mac DHCP Iot Lock Enable Cross Load SW Cir LED Timer	

Options			
Fans Control	Fans Speed Stage Silence Super Silence	Auto ON/OFF	Fans Speed select Constant Fans
Disp.Setting	Shutoff Time Flip Display Key Lock DispFlash	02-60m ON/OFF ON/OFF ON/OFF	Display shutoff time Reverse 180 degree Key Lock DispFlash
Temp. C/F	Celsius Fahrenheit	ON/OFF	Temperature switch between °C / °F
Initial Pos.	PAN =XXX	ON/OFF	Initial effect position
Wireless DMX	Activate WDMX Rest WDMX	ON/OFF	Activate WDMX Rest WDMX
Dim Curve	Square Low Linear	ON/OFF	
Refresh Select	12K 2.4K 16K 25K	ON/OFF	Refresh Select
Defog	OFF Auto ON	ON/OFF	Defog off Defog auto Defog on
Gobo Correction	OFF OTE Cyan	ON/OFF	Gobo Correction
Reset P/T Fade	ON/OFF	ON/OFF	Reset P/T Fade
Frost (Progressive)	ON/OFF	ON/OFF	Frost (Progressive)
Trigger	DMX Value Disp. Set to Slave Auto Program	PAN.... Slave 1, Slave 2, Slave 3 Master/Alone	DMX Value Disp. Set to Slave Auto Program
Reset Default	ON/OFF	ON/OFF	Restore factory set.
Reset User	Address Mode Fans Speed	DMX address: 001-XXX Decimal Universe: XXXXX Net: XX Sub Net: X Universe: X Signal: DMX/WDMX/Art-Net/sACN Extend Mode Auto Stage Silence Super Silence ON/OFF	DMX Address Decimal Universe Net Sub-Net Universe Signal User's mode to change channel numbers Fans Speed select Constant Fans
Info			
Time Info.	Current Time Ttl Life Hrs Last Run Hrs LED Hours Timer PIN Cir Last Run		XXXX(Hours) XXXX(Hours) XXXX(Hours) XXXX(Hours) Password = XXX ON/OFF
Temp. Info	Head Temp.		XXX°C/°F
Humidity	x%		Humidity

Info		
Encoder Info	xxx	Encoder Info
Fan Info.	xxxx RPM	Fan information
LED Type	xxx	LED Type
Software Ver	V1.0.....	Software version
Signal Quality	xxx	Signal Quality Information
Network	IP, Mask, Mac	Network
Error Info.	Error Record 1	Error Info.
SN	Product: xxxxx... LED: xxxxx...	SN
RDM UID	UID: xxxxx-xxxxxxx	RDM UID
Test		
Home	All Pan&Tilt Colour Gobo Other	All Pan&Tilt Colour Gobo Other
Test Channel	PAN	Test function
Manual Ctrl.	PAN =XXX :	Fine adjustment of the lamp
Calibration	-Password- PAN :	Password "050" Calibrate and adjust the effects to standard/right position
Cmy Comp	Service PIN C M :	Cmy Comp
Magn Auto Cal	-Password- Calibration	Magn Auto Cal
Magn P/T 50%	-Password- PAN TILT Calibration	Magn P/T 50%
Gobo Replace	Gobo Wheel 1 Gobo Wheel 2	Gobo Replace
Preset		
Select Prog.	Prog. Part 1 = Program 1 ~ 10 Program 1 Prog. Part 2 = Program 1 ~ 10 Program 2 Prog. Part 3 = Program 1 ~ 10 Program 3	Select programs to be run
Edit Prog.	Program 1 : Program 10	Program Test Step 01=SCxxx Step 04=SCxxx
Edit Scenes	Edit Scene 001 ~ Edit Scene 250	Pan,Tilt,..... --Fade Time-- --Scene Time-- Input By Outside
Scenes Input	XX-XX	Scenes Input

10.1 > ADDRESS

10.1.1. Address

With this function, you can adjust the DMX address.

- Double-click the center button to access the main menu.
- Tap the <Up/Down> button until "Address" is displayed.
- Double-click the center button to access "Address". Tap the <Up/Down> button to select "Main".
- Double-click the center button to access "Address" menu. The

display will show "DMX Address: 001-XXX", "Decimal Universe: XXXXX", "Net: XX", "Sub-Net: X", "Universe: X", "Signal: DMX/WDMX/Art-Net/sACN".

- Double-click the center button to confirm or long press the center button to return to the main menu.

10.2 > MODE

10.2.1. User Mode

With this function, you can create user defined channel orders.

- Double-click the center button to access main menu. Tap the <Up/Down> button until "Mode" is displayed. Double-click the center button to enter.
- Press <Up/Down>, the display will show "User Mode".
- Double-click the center button to enter.
- When in "Extend Mode", press <Up/Down> button to select "Extend Mode", "Rivale Mode", "User Mode A", "User Mode B" and "User Mode C".
- Double-click the center button to confirm or long press the center button to return to the main menu.

10.3 > OPTIONS

10.3.1. Status

No DMX Status

With this function, you can choose the unit behavior in case no signal is detected between close, hold, and Auto.

- Double-click the center button to access main menu.
- Tap the <Up/Down> button until "Options" is displayed.
- Double-click the center button to access "Options". Tap the <Up/Down> button to select "Status".
- Double-click the center button to access "Status" menu. Tap the <Up/Down> button to select "No DMX Status".
- Double-click the center button to access "No DMX Status". The display will show "Hold". Tap the <Up/Down> button to select "Close", "Auto".
- Double-click the center button to confirm or long-press the center button to return to the main menu.

Sun Protection

When this function is activated, the unit will automatically tilt down its head toward the ground when no signal is detected.

- Double-click the center button to access the main menu.
- Tap the <Up/Down> button until "Options" is displayed.
- Double-click the center button to access "Options". Tap the <Up/Down> button to select "Status".
- Double-click the center button to access the "Status" menu. Tap the <Up/Down> button to select "Sun Protection".
- Double-click the center button to access "Sun Protection". The display will show "ON". Tap the <Up/Down> button to select "OFF".
- Double-click the center button to confirm or long-press the center button to return to the main menu.

Pan Reverse

With this function you can reverse the Pan-movement.

- Double-click the center button to access main menu.
- Tap the <Up/Down> button until "Options" is displayed.
- Double-click the center button to access "Options". Tap the <Up/Down> button to select "Status".
- Double-click the center button to access "Status" menu. Tap the <Up/Down> button to select "Pan Reverse".
- Double-click the center button to access "Pan Reverse". The display will show "OFF". Tap the <Up/Down> button to select "ON".
- Double-click the center button to confirm or long press the center button to return to the main menu.

Tilt Reverse

With this function, you can reverse the Tilt-movement.

- Double-click the center button to access the main menu.

- Tap the <Up/Down> button until "Options" is displayed.
- Double-click the center button to access "Options". Tap the <Up/Down> button to select "Status".
- Double-click the center button to access "Status" menu. Tap the <Up/Down> button to select "Tilt Reverse".
- Double-click the center button to access "Tilt Reverse". The display will show "OFF". Tap the <Up/Down> button to select "ON".
- Double-click the center button to confirm or long-press the center button to return to the main menu.

Pan Degree

With this function, you can select Pan degree between 630 or 540.

- Double-click the center button to access main menu.
- Tap the <Up/Down> button until "Options" is displayed.
- Double-click the center button to access "Options". Tap the <Up/Down> button to select "Status".
- Double-click the center button to access "Status" menu. Tap the <Up/Down> button to select "Pan Degree".
- Double-click the center button to access "Pan Degree". The display will show "540". Tap the <Up/Down> button to select "630".
- Double-click the center button to confirm or long-press the center button to return to the main menu.

Tilt Degree

With this function, you can select Tilt degree for 270 or 540.

- Double-click the center button to access the main menu.
- Tap the <Up/Down> button until "Options" is displayed.
- Double-click the center button to access "Options". Tap the <Up/Down> button to select "Status".
- Double-click the center button to access "Status" menu. Tap the <Up/Down> button to select "Tilt Degree".
- Double-click the center button to access "Tilt Degree". The display will show "270". Tap the <Up/Down> button to select "540".
- Double-click the center button to confirm or long-press the center button to return to the main menu.

Feedback

This function allows you to activate or deactivate the automatic repositioning of the Pan & Tilt in case of an accidental/manual move of the yoke.

- Double-click the center button to access main menu.
- Tap the <Up/Down> button until "Options" is displayed.
- Double-click the center button to access "Options". Tap the <Up/Down> button to select "Status".
- Double-click the center button to access "Status" menu. Tap the <Up/Down> button to select "Feedback".
- Double-click the center button to access "Feedback". The display will show "ON". Tap the <Up/Down> button to select "OFF".
- Double-click the center button to confirm or long-press the center button to return to the main menu.

Encoder Select

- Double-click the center button to access main menu.
- Tap the <Up/Down> button until "Options" is displayed.
- Double-click the center button to access "Options". Tap the <Up/Down> button to select "Status".
- Double-click the center button to access "Status" menu. Tap the <Up/Down> button to select "Encoder Select".
- Double-click the center button to access "Encoder Select". The display will show "Magnet". Tap the <Up/Down> button to select "Photoelectric".
- Double-click the center button to confirm or long press the center button to return to the main menu.

Init PAN

This function allows you to deactivate the Pan movement.

- Double-click the center button to access main menu.

- Tap the <Up/Down> button until "Options" is displayed.
- Double-click the center button to access "Options". Tap the <Up/Down> button to select "Status".
- Double-click the center button to access "Status" menu. Tap the <Up/Down> button to select "Init PAN".
- Double-click the center button to access "Init PAN". The display will show "ON". Tap the <Up/Down> button to select "OFF".
- Double-click the center button to confirm or long press the center button to return to the main menu.

Init TILT

This function allows you to deactivate the Tilt movement.

- Double-click the center button to access main menu.
- Tap the <Up/Down> button until "Options" is displayed.
- Double-click the center button to access "Options". Tap the <Up/Down> button to select "Status".
- Double-click the center button to access "Status" menu. Tap the <Up/Down> button to select "Init TILT".
- Double-click the center button to access "Init TILT". The display will show "ON". Tap the <Up/Down> button to select "OFF".
- Double-click the center button to confirm or long press the center button to return to the main menu.

Prerig INIT

Allows you to activate a special init process: Pan init then Tilt init process when unit is used in prerig trusses

- Double-click the center button to access main menu.
- Tap the <Up/Down> button until "Options" is displayed.
- Double-click the center button to access "Options". Tap the <Up/Down> button to select "Status".
- Double-click the center button to access "Status" menu. Tap the <Up/Down> button to select "Prerig INIT".
- Double-click the center button to access "Prerig INIT". The display will show "OFF". Tap the <Up/Down> button to select "ON".
- Double-click the center button to confirm or long press the center button to return to the main menu.

Reset Mode

Allows you to choose between fast reset on complete gobo index reset (longer)

- Double-click the center button to access main menu.
- Tap the <Up/Down> button until "Options" is displayed.
- Double-click the center button to access "Options". Tap the <Up/Down> button to select "Status".
- Double-click the center button to access "Status" menu. Tap the <Up/Down> button to select "Reset Mode".
- Double-click the center button to access "Reset Mode". The display will show "Fast". Tap the <Up/Down> button to select "All Rot Gobos".
- Double-click the center button to confirm or long press the center button to return to the main menu.

Pan/Tilt Spd

With this function, you can select Pan & Tilt speed from "Fast", "Medium", "Slow".

- Double-click the center button to access main menu.
- Tap the <Up/Down> button until "Options" is displayed.
- Double-click the center button to access "Options". Tap the <Up/Down> button to select "Status".
- Double-click the center button to access "Status" menu. Tap the <Up/Down> button to select "Pan/Tilt Spd".
- Double-click the center button to access "Pan/Tilt Spd". The display will show "Fast". Tap the <Up/Down> button to select "Fast", "Medium", "Slow", "FS Mode".
- Double-click the center button to confirm or long press the center button to return to the main menu.

CMY Spd

- Double-click the center button to access main menu.
- Tap the <Up/Down> button until "Options" is displayed.
- Double-click the center button to access "Options". Tap the <Up/Down> button to select "Status".
- Double-click the center button to access "Status" menu. Tap the <Up/Down> button to select "CMY Spd".
- Double-click the center button to access "CMY Spd". The display will show "Fast". Tap the <Up/Down> button to select "Fast", "Medium", "Slow".
- Double-click the center button to confirm or long press the center button to return to the main menu.

Zoom/Focus Spd

- Double-click the center button to access main menu.
- Tap the <Up/Down> button until "Options" is displayed.
- Double-click the center button to access "Options". Tap the <Up/Down> button to select "Status".
- Double-click the center button to access "Status" menu. Tap the <Up/Down> button to select "Zoom/Focus Spd".
- Double-click the center button to access "Zoom/Focus Spd". The display will show "Fast". Tap the <Up/Down> button to select "Fast", "Medium", "Slow".
- Double-click the center button to confirm or long press the center button to return to the main menu.

Framing Mode

- Double click the center button to access main menu.
- Tap the <Up/Down> button until "Options" is displayed.
- Double click the center button to access "Options". Tap the <Up/Down> button to select "Status".
- Double click the center button to access "Options" menu. Tap the <Up/Down> button to select Framing Mode
- Double click the center button to access Framing Mode. The display will show Constant OFF. Tap the <Up/Down> button to select Constant ON
- Double click the center button to confirm or long press the center button to return to the main menu.

Reset LED Fade

Allows the Light output to fade out and in during the reset process without DMX signal for 15 mins (Factory default). The fixture will perform a reset sequence once DMX is back.

- Double-click the center button to access main menu.
- Tap the <Up/Down> button until "Options" is displayed.
- Double-click the center button to access "Options". Tap the <Up/Down> button to select "Status".
- Double-click the center button to access "Status" menu. Tap the <Up/Down> button to select "Reset LED Fade".
- Double-click the center button to access "Reset LED Fade". The display will show "OFF". Tap the <Up/Down> button to select "ON".
- Double-click the center button to confirm or long press the center button to return to the main menu.

Hibernation

The device and stepper motors will be powered off if the unit stays without DMX signal for 15 mins (Factory default). The fixture will perform a reset sequence once DMX is back.

- Double-click the center button to access main menu.
- Tap the <Up/Down> button until "Options" is displayed.
- Double-click the center button to access "Options". Tap the <Up/Down> button to select "Status".
- Double-click the center button to access "Status" menu. Tap the <Up/Down> button to select "Hibernation".
- Double-click the center button to access "Hibernation". The display will show "OFF". Tap the <Up/Down> button to select "01M", "02M", ... "99M".
- Double-click the center button to confirm or long press the center button to return to the main menu.

DMX Output

- Double-click the center button to access main menu.
- Tap the <Up/Down> button until "Options" is displayed.
- Double-click the center button to access "Options". Tap the <Up/Down> button to select "Status".
- Double-click the center button to access "Status" menu. Tap the <Up/Down> button to select "DMX Output".
- Double-click the center button to access "DMX Output". The display will show "OFF". Tap the <Up/Down> button to select "ON".
- Double-click the center button to confirm or long press the center button to return to the main menu.

Data Collect

- Double-click the center button to access main menu.
- Tap the <Up/Down> button until "Options" is displayed.
- Double-click the center button to access "Options". Tap the <Up/Down> button to select "Status".
- Double-click the center button to access "Status" menu. Tap the <Up/Down> button to select "Data Collect".
- Double-click the center button to access "Data Collect". The display will show "Disagree". Tap the <Up/Down> button to select "Agree".
- Double-click the center button to confirm or long press the center button to return to the main menu.

4G/Wifi

- Double click the center button to access main menu.
- Tap the < Up/Down> button until "Options" is displayed.
- Double click the center button to access ". Tap the <Up/Down> button to select "Status".
- Double click the center button to access " menu. Tap the <Up/Down> button to select 4G Wifi
- Double click the center button to access 4G Wifi. The display will show "Wifi". Tap the <Up/Down> button to select 4G
- Double click the center button to confirm or long press the center button to return to the main menu

Wifi Info

- Double click the center button to access main menu.
- Tap the < Up/Down> button until "Options" is displayed.
- Double click the center button to access "Options". Tap the <Up/Down> button to select "Status".
- Double click the center button to access "Status" menu. Tap the <Up/Down> button to select "Wifi Info".
- Double click the center button to access Wifi Info. The display will show "No". Tap the <Up/Down> button to select "Yes".
- Double click the center button to confirm or long press the center button to return to the main menu.

10.3.2. Service PIN**Password**

The Password for this function is "050".

Set IP

- Double-click the center button to access main menu.
- Tap the <Up/Down> button until "Options" is displayed.
- Double-click the center button to access "Options". Tap the <Up/Down> button to select "Service PIN".
- Double-click the center button to access "Service PIN" menu. Tap the <Up/Down> button to select "Set IP".
- Double-click the center button to access "Set IP". The display will show "XXX.XXX.XXX.XXX".
- Double-click the center button to confirm or long press the center button to return to the main menu.

Set Mask IP

- Double-click the center button to access main menu.

- Tap the <Up/Down> button until "Options" is displayed.
- Double-click the center button to access "Options". Tap the <Up/Down> button to select "Service PIN".
- Double-click the center button to access "Service PIN" menu. Tap the <Up/Down> button to select "Set Mask IP".
- Double-click the center button to access "Set Mask IP". The display will show "XXX.XXX.XXX.XXX".
- Double-click the center button to confirm or long press the center button to return to the main menu.

Reset From Mac

- Double-click the center button to access main menu.
- Tap the <Up/Down> button until "Options" is displayed.
- Double-click the center button to access "Options". Tap the <Up/Down> button to select "Service PIN".
- Double-click the center button to access "Service PIN" menu. Tap the <Up/Down> button to select "Reset From Mac".
- Double-click the center button to access "Reset From Mac". The display will show "OFF". Tap the <Up/Down> button to select "ON".
- Double-click the center button to confirm or long press the center button to return to the main menu.

DHCP

- Double-click the center button to access main menu.
- Tap the <Up/Down> button until "Options" is displayed.
- Double-click the center button to access "Options". Tap the <Up/Down> button to select "Service PIN".
- Double-click the center button to access "Service PIN" menu. Tap the <Up/Down> button to select "DHCP".
- Double-click the center button to access "DHCP". The display will show "OFF". Tap the <Up/Down> button to select "ON".
- Double-click the center button to confirm or long press the center button to return to the main menu.

lot Lock Enable

- Double-click the center button to access main menu.
- Tap the <Up/Down> button until "Options" is displayed.
- Double-click the center button to access "Options". Tap the <Up/Down> button to select "Service PIN".
- Double-click the center button to access "Service PIN" menu. Tap the <Up/Down> button to select "lot Lock Enable".
- Double-click the center button to access "lot Lock Enable". The display will show "OFF". Tap the <Up/Down> button to select "ON".
- Double-click the center button to confirm or long press the center button to return to the main menu.

Cross Load SW

This function allows you to upload the current SW version to other units using a DMX connection. Do not disconnect the units before the process is done.

- Double-click the center button to access main menu.
- Tap the <Up/Down> button until "Options" is displayed.
- Double-click the center button to access "Options". Tap the <Up/Down> button to select "Service PIN".
- Double-click the center button to access "Service PIN" menu. Tap the <Up/Down> button to select "Cross Load SW".
- Double-click the center button to access "Cross Load SW". The display will show "OFF". Tap the <Up/Down> button to select "ON".
- Double-click the center button to confirm or long press the center button to return to the main menu.

Clr Error Info

- Double-click the center button to access main menu.
- Tap the <Up/Down> button until "Options" is displayed.
- Double-click the center button to access "Options". Tap the <Up/Down> button to select "Service PIN".
- Double-click the center button to access "Service PIN" menu. Tap

the <Up/Down> button to select "Clr Error Info".

- Double-click the center button to access "Clr Error Info". The display will show "OFF". Tap the <Up/Down> button to select "ON".
- Double-click the center button to confirm or long press the center button to return to the main menu.

10.3.3. Fans Control

Fans Speed

With this function, you can set the fans speed. Settings are Auto, Stage, Silence, and Super Silence.

- Double-click the center button to access main menu.
- Tap the <Up/Down> button until "Options" is displayed.
- Double-click the center button to access "Options". Tap the <Up/Down> button to select "Fans Control".
- Double-click the center button to access "Fans Control" menu. Tap the <Up/Down> button to select "Fans Speed".
- Double-click the center button to access "Fans Speed I". The display will show "Auto". Tap the <Up/Down> button to select "Stage", "Silence", "Super Silence".
- Double-click the center button to confirm or long press the center button to return to the main menu.

Constant Fans

Allows you to choose that the fans run continuously even when the LED is off.

- Double-click the center button to access main menu.
- Tap the <Up/Down> button until "Options" is displayed.
- Double-click the center button to access "Options". Tap the <Up/Down> button to select "Fans Control".
- Double-click the center button to access "Fans Control" menu. Tap the <Up/Down> button to select "Constant Fans".
- Double-click the center button to access "Constant Fans". The display will show "OFF". Tap the <Up/Down> button to select "ON".
- Double-click the center button to confirm or long press the center button to return to the main menu.

10.3.4. Disp. Setting

Shut off Time

With this function, you can select the delay before the LCD display turns off. Choose between 2 to 60 minutes. The default is 5 minutes.

- Double-click the center button to access main menu.
- Tap the <Up/Down> button until "Options" is displayed.
- Double-click the center button to access "Options". Tap the <Up/Down> button to select "Display Setting".
- Double-click the center button to access "Display Setting" menu. Tap the <Up/Down> button to select "Shut off Time".
- Double-click the center button to access "Shut off Time". The display will show "05m". Tap the <Up/Down> button to select "02-60m".
- Double-click the center button to confirm or long press the center button to return to the main menu.

Flip Display

With this function you can rotate the display by 180° (when the unit is rigged)

- Double-click the center button to access main menu.
- Tap the <Up/Down> button until "Options" is displayed.
- Double-click the center button to access "Options". Tap the <Up/Down> button to select "Display Setting".
- Double-click the center button to access "Display Setting" menu. Tap the <Up/Down> button to select "Flip Display".
- Double-click the center button to access "Flip Display". The display will show "OFF". Tap the <Up/Down> button to select "ON".
- Double-click the center button to confirm or long press the center button to return to the main menu.

Key Lock

With this function you can activate the automatic key lock function. If this function is activated, the keys will be locked automatically after exiting the edit mode for 15 seconds. Keeping press the <MODE/ESC> key for 3seconds if you do not need this function.

- Double-click the center button to access main menu.
- Tap the <Up/Down> button until "Options" is displayed.
- Double-click the center button to access "Options". Tap the <Up/Down> button to select "Display Setting".
- Double-click the center button to access "Display Setting" menu. Tap the <Up/Down> button to select "Key Lock".
- Double-click the center button to access "Key Lock". The display will show "OFF". Tap the <Up/Down> button to select "ON".
- Double-click the center button to confirm or long press the center button to return to the main menu.

DispFlash

With this function activated, display will flash if no signal is detected.

- Double-click the center button to access main menu.
- Tap the <Up/Down> button until "Options" is displayed.
- Double-click the center button to access "Options". Tap the <Up/Down> button to select "Display Setting".
- Double-click the center button to access "Display Setting" menu. Tap the <Up/Down> button to select "DispFlash".
- Double-click the center button to access "DispFlash". The display will show "OFF". Tap the <Up/Down> button to select "ON".
- Double-click the center button to confirm or long press the center button to return to the main menu.

10.3.5 Temperature C/F

With this function you can display the temperature in Celsius or Fahrenheit.

- Double-click the center button to access main menu.
- Tap the <Up/Down> button until "Options" is displayed.
- Double-click the center button to access "Options". Tap the <Up/Down> button to select "Temperature C/ F".
- Double-click the center button to access "Temperature C/ F". The display will show "Fahrenheit". Tap the <Up/Down> button to select "Celsius".
- Double-click the center button to confirm or long press the center button to return to the main menu.

10.3.6. Initial Pos.

With this function you can display initial effect position.

- Double-click the center button to access main menu.
- Tap the <Up/Down> button until "Options" is displayed.
- Double-click the center button to access "Options". Tap the <Up/Down> button to select "Initial Pos.".
- Double-click the center button to access "Initial Pos.". The display will show "PAN=XXX".
- Double-click the center button to confirm or long press the center button to return to the main menu.

10.3.7. Wireless

From factory, this projector is prepared for wireless data transmission (W-DMX). If you wish to de-activate W-DMX control, you can select the function "De-activate WDMX" by turning the encoder. With the function "Rest", you can log out the projector from the wireless sender.

- Double-click the center button to access main menu.
- Tap the <Up/Down> button until "Options" is displayed.
- Double-click the center button to access "Options". Tap the <Up/Down> button to select "Wireless".
- Double-click the center button to access "Wireless". The display will show "Activate WDMX". Tap the <Up/Down> button to select "Rest WDMX".
- Double-click the center button to confirm or long press the center button to return to the main menu.

10.3.8. Dim Curve

- Double-click the center button to access main menu.
- Tap the <Up/Down> button until "Options" is displayed.
- Double-click the center button to access "Options". Tap the <Up/Down> button to select "Dim Curve".
- Double-click the center button to access "Dim Curve". The display will show "Square Law". Tap the <Up/Down> button to select "Linear".
- Double-click the center button to confirm or long press the center button to return to the main menu.

10.3.9. Refresh Select

With this function you can select the PWM rate.

- Double-click the center button to access main menu.
- Tap the <Up/Down> button until "Options" is displayed.
- Double-click the center button to access "Options". Tap the <Up/Down> button to select "Refresh Select".
- Double-click the center button to access "Refresh Select". The display will show "1.2K". Tap the <Up/Down> button to select "2.4K", "16K", "25K".
- Double-click the center button to confirm or long press the center button to return to the main menu.

10.3.10. Defog

When this function activated, head fans will run continuously to help removing the potential condensation

- Double-click the center button to access main menu.
- Tap the <Up/Down> button until "Options" is displayed.
- Double-click the center button to access "Options". Tap the <Up/Down> button to select "Defog".
- Double-click the center button to access "Defog". The display will show "Auto". Tap the <Up/Down> button to select "OFF", "Auto", "ON".
- Double-click the center button to confirm or long press the center button to return to the main menu.

10.3.11. Gobo Correction

When this function is activated, Colour flag correction will be added when a gobo is used in white, to correct the Colour shifting.

- Double-click the center button to access main menu.
- Tap the <Up/Down> button until "Options" is displayed.
- Double-click the center button to access "Options". Tap the <Up/Down> button to select "Gobo Correction".
- Double-click the center button to access "Gobo Correction". The display will show "Cyan". Tap the <Up/Down> button to select "OFF", "Cyan", "CTB".
- Double-click the center button to confirm or long press the center button to return to the main menu.

10.3.12. Reset P/T Fade

- Double-click the center button to access main menu.
- Tap the <Up/Down> button until "Options" is displayed.
- Double-click the center button to access "Options". Tap the <Up/Down> button to select "Reset P/T Fade".
- Double-click the center button to access "Reset P/T Fade". The display will show "OFF". Tap the <Up/Down> button to select "ON".
- Double-click the center button to confirm or long press the center button to return to the main menu.

10.3.13. Frost (Progressive)

- Double-click the center button to access main menu.
- Tap the <Up/Down> button until "Options" is displayed.
- Double-click the center button to access "Options". Tap the <Up/Down> button to select "Frost(Progressive)".
- Double-click the center button to access "Frost(Progressive)". The display will show "ON". Tap the <Up/Down> button to select "OFF".
- Double-click the center button to confirm or long press the center button to return to the main menu.

10.3.14. Trigger

DMX Value Disp.

With this function you can display the DMX 512 value of each channel. The display automatically shows the channel with a value changing.

- Double-click the center button to access main menu.
- Tap the <Up/Down> button until "Options" is displayed.
- Double-click the center button to access "Options". Tap the <Up/Down> button to select "Trigger".
- Double-click the center button to access "Trigger" menu. Tap the <Up/Down> button to select "DMX Value Disp".
- Double-click the center button to access "DMX Value Disp". The display will show "PAN=.....".
- Double-click the center button to confirm or long press the center button to return to the main menu.

Set To Slave

With this function, you can define the device as slave.

- Double-click the center button to access main menu.
- Tap the <Up/Down> button until "Options" is displayed.
- Double-click the center button to access "Options". Tap the <Up/Down> button to select "Trigger".
- Double-click the center button to access "Trigger" menu. Tap the <Up/Down> button to select "Set To Slave".
- Double-click the center button to access "Set To Slave". The display will show "Slave1", "Slave2", "Slave3".
- Double-click the center button to confirm or long press the center button to return to the main menu.

Auto Program

With this function, you can run the internal program. You can select the desired program under "Select program". You can set the number of steps under "Edit program". You can edit the individual scenes under "Edit scenes". With this function, you can run the individual scenes either automatically, i.e. with the adjusted Step-Time.

- Double-click the center button to access main menu.
- Tap the <Up/Down> button until "Options" is displayed.
- Double-click the center button to access "Options". Tap the <Up/Down> button to select "Trigger".
- Double-click the center button to access "Trigger" menu. Tap the <Up/Down> button to select "Auto Program".
- Double-click the center button to access "Auto Program". The display will show "Master", "Alone".
- Double-click the center button to confirm or long press the center button to return to the main menu.

10.3.15. Reset Default

With this function, you can select restore factory set for ON or OFF. the default is OFF.

- Double-click the center button to access main menu.
- Tap the <Up/Down> button until "Options" is displayed.
- Double-click the center button to access "Options". Tap the <Up/Down> button to select "Reset Default".
- Double-click the center button to access "Reset Default" menu. The display will show "OFF". Tap the <Up/Down> button to select "ON".
- Double-click the center button to confirm or long press the center button to return to the main menu.

10.3.16. Reset User

Allows you to set default User settings

Address

- Double-click the center button to access main menu.
- Tap the <Up/Down> button until "Options" is displayed.
- Double-click the center button to access "Options". Tap the <Up/Down> button to select "Reset User".

- Double-click the center button to access "Reset User" menu. Tap the <Up/Down> button to select "Address".
- Double-click the center button to access "Address". The display will show "DMX Address: 001-XXX", "Decimal Universe: XXXX", "Net: XX", "Sub-Net: X", "Universe: X", "Signal: DMX/WDMX/Art-Net/sACN".
- Double-click the center button to confirm or long press the center button to return to the main menu.

Mode

- Double-click the center button to access main menu.
- Tap the <Up/Down> button until "Options" is displayed.
- Double-click the center button to access "Options". Tap the <Up/Down> button to select "Reset User".
- Double-click the center button to access "Reset User" menu. Tap the <Up/Down> button to select "Mode".
- Double-click the center button to access "Mode". The display will show "Extend Mode". Tap the <Up/Down> button to select "Rivale Mode", "User Mode A", "User Mode B" and "User Mode C".
- Double-click the center button to confirm or long press the center button to return to the main menu.

Fans Speed

- Double-click the center button to access main menu.
- Tap the <Up/Down> button until "Options" is displayed.
- Double-click the center button to access "Options". Tap the <Up/Down> button to select "Reset User".
- Double-click the center button to access "Reset User" menu. Tap the <Up/Down> button to select "Fans Speed".
- Double-click the center button to access "Fans Speed". The display will show "Auto". Tap the <Up/Down> button to select "Stage", "Silence", "Super Silence".
- Double-click the center button to confirm or long press the center button to return to the main menu.

Constant Fans

- Double-click the center button to access main menu.
- Tap the <Up/Down> button until "Options" is displayed.
- Double-click the center button to access "Options". Tap the <Up/Down> button to select "Reset User".
- Double-click the center button to access "Reset User" menu. Tap the <Up/Down> button to select "Constant Fans".
- Double-click the center button to access "Constant Fans". The display will show "OFF". Tap the <Up/Down> button to select "ON".
- Double-click the center button to confirm or long press the center button to return to the main menu.

10.4 > INFO

10.4.1. Time Info.

Current Time

With this function, you can display the temporary running time of the device from the last power on. The display shows "XXXX", "XXXX" stands for the number of hours. The counter is reset after turning the device off.

- Double-click the center button to access main menu.
- Tap the <Up/Down> button until "Info" is displayed.
- Double-click the center button to access "Info". Tap the <Up/Down> button to select "Time Info".
- Double-click the center button to access "Time Info.". Tap the <Up/Down> button to select "Current Time".
- Double-click the center button to access "Current Time". The display will show "XXXX (Hours)".
- Double-click the center button to confirm or long press the center button to return to the main menu.

Ttl Life Hrs

With this function, you can display the running time of the device. The display shows "XXXX". "XXXX" stands for the number of hours.

- Double-click the center button to access main menu.
- Tap the <Up/Down> button until "Info" is displayed.
- Double-click the center button to access "Info". Tap the <Up/Down> button to select "Time Info."
- Double-click the center button to access "Time Info.". Tap the <Up/Down> button to select "Ttl Life Hrs".
- Double-click the center button to access "Ttl Life Hrs". The display will show "XXXX (Hours)".
- Double-click the center button to confirm or long press the center button to return to the main menu.

Last Run Hrs

With this function, you can display last the running time of the device. The display shows "XXXX". "XXXX" stands for the number of hours.

- Double-click the center button to access main menu.
- Tap the <Up/Down> button until "Info" is displayed.
- Double-click the center button to access "Info". Tap the <Up/Down> button to select "Time Info."
- Double-click the center button to access "Time Info.". Tap the <Up/Down> button to select "Last Run Hrs".
- Double-click the center button to access "Last Run Hrs". The display will show "XXXX (Hours)".
- Double-click the center button to confirm or long press the center button to return to the main menu.

LED Hours

With this function, you can display the time of LED. The display shows "XXXX". "XXXX" stands for the time of LED.

- Double-click the center button to access main menu.
- Tap the <Up/Down> button until "Info" is displayed.
- Double-click the center button to access "Info". Tap the <Up/Down> button to select "Time Info."
- Double-click the center button to access "Time Info.". Tap the <Up/Down> button to select "LED Hours".
- Double-click the center button to access "LED Hours". The display will show "XXXX (Hours)".
- Double-click the center button to confirm or long press the center button to return to the main menu.

Timer PIN

With this function, you can display the timer password.

- Double-click the center button to access main menu.
- Tap the <Up/Down> button until "Info" is displayed.
- Double-click the center button to access "Info". Tap the <Up/Down> button to select "Time Info."
- Double-click the center button to access "Time Info.". Tap the <Up/Down> button to select "Timer PIN".
- Double-click the center button to access "Timer PIN". The display will show "Password=038".
- Double-click the center button to confirm or long press the center button to return to the main menu.

Clr Last Run

With this function, you can clear last run time of the fixture. The display shows "ON" or "OFF". Press "Enter" to confirm.

- Double-click the center button to access main menu.
- Tap the <Up/Down> button until "Info" is displayed.
- Double-click the center button to access "Info". Tap the <Up/Down> button to select "Time Info."
- Double-click the center button to access "Time Info.". Tap the <Up/Down> button to select "Clear Last Run".
- Double-click the center button to access "Clear Last Run". The display will show "OFF". Tap the <Up/Down> button to select "ON".
- Double-click the center button to confirm or long press the center

button to return to the main menu.

10.4.2. Temp.Info

With this function you can display the temperature on the display board of the base (near CMY-filter) in Celsius.

- Double-click the center button to access main menu.
- Tap the <Up/Down> button until "Info" is displayed.
- Double-click the center button to access "Info". Tap the <Up/Down> button to select "Temp Info".
- Double-click the center button to access "Time Info.". The display will show "XXX °C/ °F".
- Double-click the center button to confirm or long press the center button to return to the main menu.

10.4.3. Humidity

- Double-click the center button to access main menu.
- Tap the <Up/Down> button until "Info" is displayed.
- Double-click the center button to access "Info". Tap the <Up/Down> button to select "Humidity".
- Double-click the center button to access "Humidity". The display will show "x%".
- Double-click the center button to confirm or long press the center button to return to the main menu.

10.4.4. Encoder Info

- Double-click the center button to access main menu.
- Tap the <Up/Down> button until "Info" is displayed.
- Double-click the center button to access "Info". Tap the <Up/Down> button to select "Encoder Info".
- Double-click the center button to access "Encoder Info". The display will show "xxx".
- Double-click the center button to confirm or long press the center button to return to the main menu.

10.4.5. Fan Info.

With this function, you can display the fans speed of the unit.

- Double-click the center button to access main menu.
- Tap the <Up/Down> button until "Info" is displayed.
- Double-click the center button to access "Info". Tap the <Up/Down> button to select "Fan Info".
- Double-click the center button to access "Fan Info.". The display will show "xxxxRPM".
- Double-click the center button to confirm or long press the center button to return to the main menu.

10.4.6. LED Type

- Double-click the center button to access main menu.
- Tap the <Up/Down> button until "Info" is displayed.
- Double-click the center button to access "Info". Tap the <Up/Down> button to select "LED Type".
- Double-click the center button to access "LED Type". The display will show "xxx".
- Double-click the center button to confirm or long press the center button to return to the main menu.

10.4.7. Software Ver

With this function, you can display the software version of the device.

- Double-click the center button to access main menu.
- Tap the <Up/Down> button until "Info" is displayed.
- Double-click the center button to access "Info". Tap the <Up/Down> button to select "Software Ver".
- Double-click the center button to access "Software Ver". The display will show "Ver x.x.x".
- Double-click the center button to confirm or long press the center button to return to the main menu.

10.4.8. Signal Quality

- Double-click the center button to access main menu.
- Tap the <Up/Down> button until "Info" is displayed.
- Double-click the center button to access "Info". Tap the <Up/Down> button to select "Signal Quality".
- Double-click the center button to access "Signal Quality". The display will show "xxx".
- Double-click the center button to confirm or long press the center button to return to the main menu.

10.4.9. Network

- Double-click the center button to access main menu.
- Tap the <Up/Down> button until "Info" is displayed.
- Double-click the center button to access "Info". Tap the <Up/Down> button to select "Network".
- Double-click the center button to access "Network". The display will show "IP". Turn the center button to select "Mask", "Mac".
- Double-click the center button to confirm or long press the center button to return to the main menu.

10.4.10. Error Info

- Double-click the center button to access main menu.
- Tap the <Up/Down> button until "Info" is displayed.
- Double-click the center button to access "Info". Tap the <Up/Down> button to select "Error Info".
- Double-click the center button to access "Error Info". The display will show "Error Record 1", ".....", "Error Record 10".
- Double-click the center button to confirm or long press the center button to return to the main menu.

10.4.11. SN

- Double-click the center button to access main menu.
- Tap the <Up/Down> button until "Info" is displayed.
- Double-click the center button to access "Info". Tap the <Up/Down> button to select "SN".
- Double-click the center button to access "SN". The display will show "Product:xxxxx...", "LED:xxxxx...".
- Double-click the center button to confirm or long press the center button to return to the main menu.

10.4.12. RDM UID

- Double-click the center button to access main menu.
- Tap the <Up/Down> button until "Info" is displayed.
- Double-click the center button to access "Info". Tap the <Up/Down> button to select "RDM UID".
- Double-click the center button to access "RDM UID". The display will show "UID: xxxx-xxxxxxx".
- Double-click the center button to confirm or long press the center button to return to the main menu.

10.5 > TEST

10.5.1. Home

With this function you can reset the device via the buttons. You can select the different reset functions using the buttons.

- Double-click the center button to access main menu.
- Tap the <Up/Down> button until "Test" is displayed.
- Double-click the center button to access "Test". Tap the <Up/Down> button to select "Home".
- Double-click the center button to access "Home". The display will show "All". Tap the <Up/Down> button to select "All", "Pan&Tilt", "Colour", "Gobo", "Other".
- Double-click the center button to confirm or long press the center button to return to the main menu.

10.5.2. Test Channel

With this function you can test each channel's function to ensure correct operation.

- Double-click the center button to access main menu.
- Tap the <Up/Down> button until "Test" is displayed.
- Double-click the center button to access "Test". Tap the <Up/Down> button to select "Test Channel".
- Double-click the center button to access "Test Channel". The display will show "Pan". Tap the <Up/Down> button to select other channel.
- Double-click the center button to confirm or long press the center button to return to the main menu.

10.5.3. Manual Control

Allows you to manually control each feature of the unit

- Double-click the center button to access main menu.
- Tap the <Up/Down> button until "Test" is displayed.
- Double-click the center button to access "Test". Tap the <Up/Down> button to select "Manual control".
- Double-click the center button to access "Manual control". The display will show "PAN=XXX".
- Double-click the center button to confirm or long press the center button to return to the main menu.

10.5.4. Calibration

With this function, you can calibrate and adjust the effect wheels to their correct positions. The password of calibrate values is 050.

- Double-click the center button to access main menu.
- Tap the <Up/Down> button until "Test" is displayed.
- Double-click the center button to access "Test". Tap the <Up/Down> button to select "Calibration".
- Double-click the center button to access "Calibration". The display will show "Password=050".
- Double-click the center button to confirm or long press the center button to return to the main menu.

10.5.5. Cmy Comp

- Double-click the center button to access main menu.
- Tap the <Up/Down> button until "Test" is displayed.
- Double-click the center button to access "Test". Tap the <Up/Down> button to select "Calibration".
- Double-click the center button to access "Cmy Comp". The display will show "Password=050".
- Double-click the center button to confirm or long press the center button to return to the main menu.

10.5.6. Magn Auto Cal

- Double-click the center button to access main menu.
- Tap the <Up/Down> button until "Test" is displayed.
- Double-click the center button to access "Test". Tap the <Up/Down> button to select "Magn Auto Cal".
- Double-click the center button to access "Magn Auto Cal". The display will show "Password=050".
- Double-click the center button to confirm or long press the center button to return to the main menu.

10.5.7. Magn P/T 50%

- Double-click the center button to access main menu.
- Tap the <Up/Down> button until "Test" is displayed.
- Double-click the center button to access "Test". Tap the <Up/Down> button to select "Magn P/T 50%".
- Double-click the center button to access "Magn P/T 50%". The display will show "Password=050".
- Double-click the center button to confirm or long press the center button to return to the main menu.

10.5.8. Gobo Replace

- Double-click the center button to access main menu.
- Tap the <Up/Down> button until "Test" is displayed.
- Double-click the center button to access "Test". Tap the <Up/Down> button to select "Gobo Replace".

- Double-click the center button to access "Gobo Replace". The display will show "Gobo Wheel 1". "Gobo Wheel 2".
- Double-click the center button to confirm or long press the center button to return to the main menu.

10.6 > PRESET

- Double-click the center button to access main menu.
- Tap the <Up/Down> button until "Preset" is displayed.
- Double-click the center button to access "Preset". Tap the <Up/Down> button to select "Select prog.", "Edit prog.", "Edit Scenes", "Scenes Input".
- Double-click the center button to confirm or long press the center button to return to the main menu.

Run the auto program: A master fixture can output to three different program signals to the slave fixture to operate. It means the host will send cyclically in the following orders (The host will keep operating the program of Part 1) Then the slave fixture will make the selectively receiving according to its own set.



- If the slave fixture chooses Run For Slave 1 from the menu of 1-3, then it will receive the part 1's automatic program from link, in the same way, when the slave fixture chooses Run For Slave 2, then it will receive the part 2's automatic program from link.
- Enter the menu of 1-3 Function Mode---Set To Slave. Here to set machine operate which part of the program during the host-slave connection
- Enter the menu of 1-4, 1-5 Function Mode---Set To Master
- Enter the menu of 8-1 Edit Program---Auto Program Part1. The host outputs three groups driven program---Part1, Part2, Part3 (Part1 program runs the same effect as the host)
- Enter the menu of 8-2 Edit Program---Edit Program. Edit the program's connection, connect the scene in order
- The editor of the scene, there are as many as 250 scenario editors, and every scene can have a program connection of 10.

Note:
Part 2, Part 3 repeat in accordance with the Part1's repeat. For example: When Part 1 uses Program 2, Part 2 uses Program 4, Part 3 uses Program 6, Assume:Program 2 includes scene of 10, 11, 12, 13, Program 4 includes scene of 8, 9, 10; Program 6 includes scene of 12, 13, 14, 15. Then it will run as below.

Example:

Part 1:



Part 2:



Part 3:



11. NFC

When the fixture is powered on, you can use a NFC smartphone installed with the Ayrton App to scan the NFC tag area of the fixture to read some of the information or settings inside the display menu, such as product name, software version, UID, DMX Start Address, Universe, User Mode, Options, Information, etc. You can also change some of the settings and push to write inside the fixture menu.

When the fixture is not powered on, you can still use the App to read the NFC info and write the settings into the NFC tag,

the written data will be automatically synchronized into the fixture menu at next time the fixture is powered on.

Link to download the application: <https://qrstud.io/ayrtonnfc>

Note:

- Before using, make sure there is NFC function on your smartphone and it is activated, Download and install the Ayrton App;
- The NFC tag on the fixture is right under the LCD window;
- The NFC reader area vary on different smartphones, identify the correct area on your smartphone before scanning the NFC tag on the fixture;
- When scanning, make sure the NFC reader area of your smartphone close enough to the LCD window and hold still the smartphone for 3 seconds until reading successfully.

12. DMX PROTOCOL

Scan the QR code on the cover page to download the DMX CHART.

13. ERROR MESSAGES

When you turn on the device, it will first perform a reset. The display may show "Err channel is XX" should there be problems with one or more functions. "XX" stands for channel 1, 2, 3, 4, 5, 6 etc whose sensor has encountered a problem. For example, when the display shows "Err channel is Pan movement", it means there is an error on channel 1. If there are errors on channel 1, channel 3, channel 6 at the same time, you may see the error message, "Err channel is Pan movement"; "Err channel is Tilt movement"; "Err channel is Shutter", flash twice, and then the device will generate a second reset. If the error messages persist after performing a reset more than twice, the channels which have errors may not work properly however, all other functions can work as usual. Please contact your dealer or manufacturer for service. Self repair is not allowed.

PAN- movement Er

(PAN- yoke movement error) This message will appear after the reset of the fixture if the yoke's magnetic-indexing circuit malfunction (Optical Sensor or Magnetic Sensor fails) or the stepper motor is defective (or its driving IC on the main PCB). The PAN-movement is not located in the default position after the reset.

TILT- movement Er

(TILT- head movement error) This message will appear after the reset of the fixture if the head's magnetic-indexing circuit malfunctions ((Optical Sensor or Magnetic Sensor fails)) or the stepper motor is defective (or its driving IC on the main PCB). The TILT-movement is not located in the default position after the reset.

Zoom wheel Er

(Zoom wheel error) This message will appear after the reset of the fixture if the head's magnetic-indexing circuit malfunctions (Optical Sensor or Magnetic Sensor fails) or the stepper motor is defective (or its driving IC on the main PCB). The Zoom -movement is not located in the default position after the reset.

Focus wheel Er

(Focus wheel error) This message will appear after the reset of the fixture if the head's magnetic-indexing circuit malfunctions (Optical Sensor or Magnetic Sensor fails) or the stepper motor is defective (or its driving IC on the main PCB). The Focus -movement is not located in the default position after the reset.

Colour wheel Er

(Colour wheel- error) This message will appear after the reset of the fixture if the head's magnetic-indexing circuit malfunctions (sensor failed or magnet missing) or the stepper motor is defective (or its driving IC on the main PCB). The Colour - movement is not located in the default position after the reset.

Frost 2 wheel Er

(Frost 2 wheel - error) This message will appear after the reset of the fixture if the head's magnetic-indexing circuit malfunctions (sensor failed or magnet missing) or the stepper motor is defective (or its driving IC on the main PCB). The Frost 2 - movement is not located in the default position after the reset.

Animation_Rot wheel Er

(Animation_Rot wheel- error) This message will appear after the reset of the fixture if the head's magnetic-indexing circuit malfunctions (sensor failed or magnet missing) or the stepper motor is defective (or its driving IC on the main PCB). The Animation_Rot - movement is not located in the default position after the reset.

14. CLEANING AND MAINTENANCE

CAUTION



Disconnect from mains before starting maintenance operation



Warning! Do not place the fixture with its lens/ glass facing any people while doing the IP test!



Never use alcohol or solvent to clean the lenses.



Always run an IP test using the Ayrton IP test kit following any maintenance operation! Failure to comply with this clause will void the warranty!



Ayrton IP Kit

The operator must follow strictly the vacuum and pressure setting values as below, or use the corresponding preset fixture menu to run the IP test. any overpressure operation may cause accidental damage or injury.

	Minimum value		Maximum value		Steady time (Hold time)
	Kpa	Psi	Kpa	Psi	
Vacuum	-30	-4.35	-35	5.08	10
Pressure	25	3.63	30	4.35	10

NOTE: When using external equipment to test air tightness, air can only be filled and extracted from the exhaust hole of the bottom base, not from the exhaust hole of the fixture head.

Once the covers removed and before set them back, check the cover gasket to avoid any leak due to gasket damage. Cross tightening the die-casting covers HEX screws at the right torque value.

Use a Torque Screwdriver set at 14Kgf.cm (1.4 Nm) for metal cover or 7Kgf.cm (0.7 Nm) for plastic cover.

The following points have to be considered during inspection:

- All screws for installing the devices or parts of the device have to be tightly connected and must not be corroded.
- There must not be any deformations to the housing, lenses, rigging and installation points (ceiling, suspension, trussing).
- Motorized parts must not show any signs of wear and must move smoothly without issue.
- The power supply cables must not show any damage, material fatigue or sediment.

Checking and replacing the desiccant

The desiccant is used as humidity indication in the fixture. Dry desiccant is in blue Colour, if it is saturated with water, its Colour changes to light red. If the desiccant Colour changes to pink, the desiccant is losing efficacy, it must be replaced.

CAUTION

Unplug the fixture from mains before checking or replacing desiccant!

Do not check or replace desiccant in a damp environment!

Further instructions depending on the installation location and usage have to be adhered to by a qualified installer and any safety concerns have to be removed. We recommend frequent cleaning of the device. Please use a moist, lint-free cloth. Never use alcohol or solvents. Please refer to the instructions under "Installation instructions".

Should you need any spare parts, please order genuine parts from your local dealer.



AYRTON

Digital Lighting

